



Evaluating the **AD7327/AD7328**

FEATURES

Full-featured evaluation board for the **AD7327/AD7328**
PC control in conjunction with the system demonstration
platform (**EVAL-SDP-CB1Z**)
PC software for control and data analysis (time and
frequency domain)
Standalone capability

EVAL-AD7327SDZ/EVAL-AD7328SDZ KIT CONTENTS

EVAL-AD7327SDZ/EVAL-AD7328SDZ evaluation board
Evaluation software CD for the **AD7327/AD7328**
9 V mains power supply adapter

ADDITIONAL EQUIPMENT NEEDED

System demonstration platform (**EVAL-SDP-CB1Z**)
Precision analog signal source
SMB cables
USB cables

EVALUATION BOARD DESCRIPTION

The **EVAL-AD7327SDZ/EVAL-AD7328SDZ** is a full-featured evaluation board, designed to allow the user to easily evaluate all features of the **AD7327/AD7328**. The evaluation board can be controlled via the SDP connector (J2). The **EVAL-SDP-CB1Z** board allows the evaluation board to be controlled via the USB port of a PC using the **AD7327/AD7328** evaluation software.

The **EVAL-AD7327SDZ/EVAL-AD7328SDZ** generates all required power supplies on-board and supplies power to the **EVAL-SDP-CB1Z** controller board.

On-board components include the following:

- **AD8597**: ultralow noise op amp
- **ADP1613**: step-up PWM dc-to-dc switching converter
- **ADP3303-5**: high accuracy anyCAP® 200 mA low dropout linear regulator
- **ADP2301**: 1.2 A, 20 V, 1.4 MHz nonsynchronous step-down switching regulator
- **ADM1185**: quad voltage monitor and sequencer
- **ADP190**: logic controlled, high-side power switch
- **ADG3308**: low voltage, 1.15 V to 5.5 V, 8-channel bidirectional logic level translator
- **AD780**: 5 V/3.0 V ultrahigh precision band gap voltage reference

Various link options are described in the Evaluation Board Hardware section.

TABLE OF CONTENTS

Features	1	Evaluation Board Software	9
EVAL-AD7327SDZ/EVAL-AD7328SDZ Kit Contents	1	Software Installation	9
Additional Equipment Needed	1	Launching the Software	11
Evaluation Board Description	1	Software Operation	11
Revision History	2	Description of User Software Panel	12
Functional Block Diagram	3	Register Controls	13
EVAL-AD7327SDZ/EVAL-AD7328SDZ Quick Start Guide	4	Data Capture/WaveForm Tab	14
Recommended Quick Start Guide	4	AC Testing—Data Capture/Histogram Tab	15
Evaluation Board Hardware	5	DC Testing—Data Capture/Histogram Tab	15
AD7327 Device Description	5	AC Testing—Data Capture/FFT Tab	16
AD7328 Device Description	5	Data Capture/Summary Tab	17
Hardware Link Options	5	Save File	18
Power Supplies	7	Load File	18
Serial Interface	8	Evaluation Board Schematics and Artwork	19
Analog Inputs	8		
Reference Options	8		
Sockets/Connectors	8		
EVAL-AD7327SDZ/EVAL-AD7328SDZ Basic Hardware Setup	8		

REVISION HISTORY

10/12—Revision 0: Initial Version

FUNCTIONAL BLOCK DIAGRAM

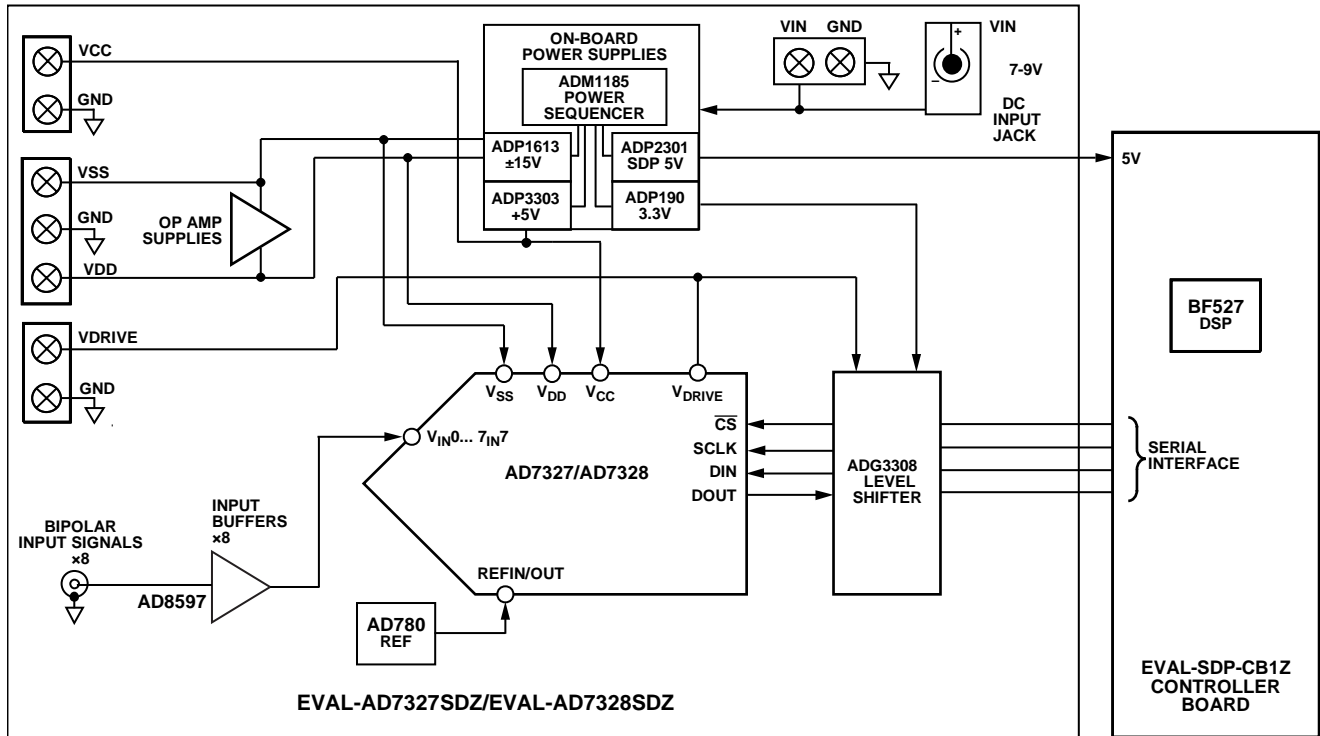

Figure 1.

10732-001

EVAL-AD7327SDZ/EVAL-AD7328SDZ QUICK START GUIDE

RECOMMENDED QUICK START GUIDE

To install the software, do the following:

1. Install the [AD7327/AD7328](#) software from the enclosed CD. When installing the software, ensure that the [EVAL-SDP-CB1Z](#) board is disconnected from the USB port of the PC. After installation, restart the PC.
2. Connect the [EVAL-SDP-CB1Z](#) board to the [EVAL-AD7327SDZ/EVAL-AD7328SDZ](#) board, as shown in Figure 2.
3. Screw the [EVAL-SDP-CB1Z](#) board to the [EVAL-AD7327SDZ/EVAL-AD7328SDZ](#) board together with the enclosed nylon screw-nut set to ensure that the boards connect firmly together.
4. Connect the 9 V power supply adapter included in the kit to the J702 connector on the [EVAL-AD7327SDZ/EVAL-AD7328SDZ](#) board.
5. Connect the [EVAL-SDP-CB1Z](#) board to the PC via the USB cable. For Windows® XP, searching for the [EVAL-SDP-CB1Z](#) drivers may be needed. If prompted by the operating system, choose to automatically search for the drivers for the [EVAL-SDP-CB1Z](#) board.
6. Launch the [AD7327/AD7328](#) software from the Analog Devices, Inc., subfolder in the **All Programs** menu.

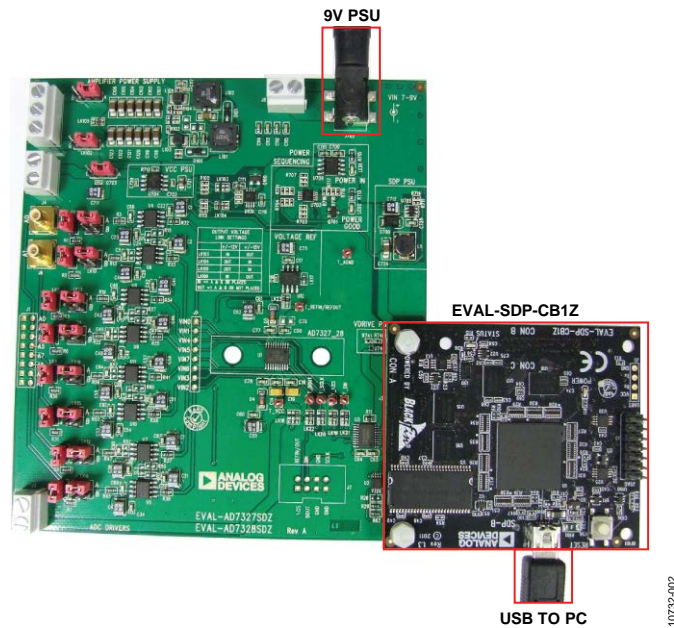

Figure 2. Setting Up the [EVAL-AD7327SDZ/EVAL-AD7328SDZ](#)

EVALUATION BOARD HARDWARE

AD7327 DEVICE DESCRIPTION

The [AD7327](#) is an 8-channel, 12-bit plus sign, successive approximation analog-to-digital converter (ADC) designed on the industrial CMOS (*i*CMOS) process. *i*CMOS is a process that combines high voltage silicon with submicron CMOS and complementary bipolar technologies. It enables the development of a wide range of high performance analog ICs capable of 33 V operation in a footprint that no previous generation of high voltage parts could achieve. Unlike analog ICs using conventional CMOS processes, *i*CMOS components can accept bipolar input signals while providing increased performance, dramatically reduced power consumption, and reduced package size.

The [AD7327](#) can accept true bipolar analog input signals. The [AD7327](#) has four software-selectable input ranges: ± 10 V, ± 5 V, ± 2.5 V, and 0 V to +10 V. Each analog input channel can be independently programmed to one of the four input ranges. The analog input channels on the [AD7327](#) can be programmed to be single-ended, true differential, or pseudo differential.

The ADC contains a 2.5 V internal reference. The [AD7327](#) also allows external reference operation. If a 3 V reference is applied to the REFIN/OUT pin, the [AD7327](#) can accept a true bipolar ± 12 V analog input. Minimum ± 12 V V_{DD} and V_{SS} supplies are required for the ± 12 V input range. The ADC has a high speed serial interface that can operate at throughput rates up to 500 kSPS.

AD7328 DEVICE DESCRIPTION

The [AD7328](#) is an 8-channel, 12-bit plus sign, successive approximation ADC designed on the industrial CMOS (*i*CMOS) process. *i*CMOS is a process that combines high voltage silicon with submicron CMOS and complementary bipolar technologies. It enables the development of a wide range of high performance analog ICs capable of 33 V operation in a footprint that no

previous generation of high voltage parts could achieve. Unlike analog ICs using conventional CMOS processes, *i*CMOS components can accept bipolar input signals while providing increased performance, dramatically reduced power consumption, and reduced package size.

The [AD7328](#) can accept true bipolar analog input signals. The [AD7328](#) has four software-selectable input ranges: ± 10 V, ± 5 V, ± 2.5 V, and 0 V to +10 V. Each analog input channel can be independently programmed to one of the four input ranges. The analog input channels on the [AD7328](#) can be programmed to be single-ended, true differential, or pseudo differential.

The ADC contains a 2.5 V internal reference. The [AD7328](#) also allows for external reference operation. If a 3 V reference is applied to the REFIN/OUT pin, the [AD7328](#) can accept a true bipolar ± 12 V analog input. Minimum ± 12 V V_{DD} and V_{SS} supplies are required for the ± 12 V input range. The ADC has a high speed serial interface that can operate at throughput rates up to 1 MSPS.

Complete specifications for the [AD7327/AD7328](#) are provided in the [AD7327/AD7328](#) data sheet, available from Analog Devices, which should be consulted in conjunction with this user guide when using the [EVAL-AD7327SDZ/EVAL-AD7328SDZ](#) evaluation board.

HARDWARE LINK OPTIONS

Before using the evaluation board, the required operating setup has 23 link options that must be set. The functions of these options are outlined in Table 1. Table 1 lists the position in which all the links are set when the evaluation board is packaged. Before using the evaluation board, set the jumper and solder link (LKx) options correctly to select the appropriate operating setup. The default link positions are listed in Table 2, and the functions of these options are outlined in Table 1.

Table 1. Link Options

Link No.	Function
LK1	Sets Input A0 load to 51 Ω when inserted
LK2	Sets Input A1 load to 51 Ω when inserted
LK3	Sets Input A2 load to 51 Ω when inserted
LK4	Sets Input A3 load to 51 Ω when inserted
LK5	Sets Input A4 load to 51 Ω when inserted
LK6	Sets Input A5 load to 51 Ω when inserted
LK7	Sets Input A6 load to 51 Ω when inserted
LK8	Sets Input A7 load to 51 Ω when inserted
LK9	A0 signal selection Position A: input signal passed to input buffer amplifiers Position B: 0 V passed to input buffer amplifiers
LK10	A1 signal selection Position A: input signal passed to input buffer amplifiers Position B: 0 V passed to input buffer amplifiers

Link No.	Function
LK11	A2 signal selection Position A: input signal passed to input buffer amplifiers Position B: 0 V passed to input buffer amplifiers
LK12	A3 signal selection Position A: input signal passed to input buffer amplifiers Position B: 0 V passed to input buffer amplifiers
LK13	A4 signal selection Position A: input signal passed to input buffer amplifiers Position B: 0 V passed to input buffer amplifiers
LK14	A5 signal selection Position A: input signal passed to input buffer amplifiers Position B: 0 V passed to input buffer amplifiers
LK15	A6 signal selection Position A: input signal passed to input buffer amplifiers Position B: 0 V passed to input buffer amplifiers
LK16	A7 signal selection Position A: input signal passed to input buffer amplifiers Position B: 0 V passed to input buffer amplifiers
LK17	VREF voltage selection (0 Ω) Inserted: VREF = 3.0 V Removed: VREF = 2.5 V
LK18	VDRIVE selection Position A: VDRIVE = 3.3 V Position B: VDRIVE = VCC Position C: VDRIVE set externally via Socket J3, Pin 2
LK19	\overline{CS} selection Position A: \overline{CS} sourced from the EVAL-SDP-CB1Z Position B: \overline{CS} sourced externally via J7, Pin 1
LK20	SCLK selection Position A: SCLK sourced from the EVAL-SDP-CB1Z Position B: SCLK sourced externally via J7, Pin 8
LK21	DIN selection Position A: DIN sourced from the EVAL-SDP-CB1Z Position B: DIN sourced externally via J7, Pin 4
LK22	DOOUT Selection Position A: DOOUT sourced from the EVAL-SDP-CB1Z Position B: DOOUT sourced externally via J7, Pin 3
LK23	REFIN/REFOUT selection Position A: REFIN/REFOUT supplied from the on-board precision reference AD780 Position B: REFIN/REFOUT supplied externally via J7, Pin 2 Open: internal reference used; must be enabled over SPORT
LK101 ¹	VSS selection Position A: VSS supplied from on-board supply Position B: VSS supplied from external source via J100 Terminal 1
LK102 ¹	VDD selection Position A: VDD supplied from on-board supply Position B: VDD supplied from external source via J100 Terminal 3

Link No.	Function		
LK103, LK104, LK105, LK106	Sets the VDD and VSS levels when using the on-board supplies		
	Link	±12V	±15V
	LK103	POP (place both 0 Ω resistors)	NOPOP (neither 0 Ω resistor is placed)
	LK104	NOPOP (neither 0 Ω resistor is placed)	POP (place both 0 Ω resistors)
	LK105	NOPOP (neither 0 Ω resistor is placed)	POP (place both 0 Ω resistors)
	LK106	POP (place both 0 Ω resistors)	NOPOP (neither 0 Ω resistor is placed)
LK701	VCC selection Position A: VCC supplied from on-board 5 V supply Position B: VDD supplied from external source via J703 Terminal 1		
SL1 to SL4	Not used		

¹ Both LK101 and LK102 should always be in matching positions.

Table 2. Link Options—Setup Conditions

Link No.	Position	Function
LK1 to LK8	Inserted	Signal inputs, A0 to A7, set to 51 Ω
LK9 to LK16	A	Input signals passed to input buffer amplifiers
LK17	A	Output from AD780 set to 3.0 V
LK18	A	VDRIVE pin on AD7327/AD7328 set to 3.3 V
LK19	A	\overline{CS} pin on the AD7327/AD7328 is connected to the EVAL-SDP-CB1Z board
LK20	A	SCLK pin on the AD7327/AD7328 is connected to the EVAL-SDP-CB1Z board
LK21	A	DIN pin on the AD7327/AD7328 is connected to the EVAL-SDP-CB1Z board
LK22	A	DOOUT pin on the AD7327/AD7328 is connected to the EVAL-SDP-CB1Z board
LK23	A	VREF is supplied from the AD780 precision voltage reference
LK101	A	VSS supplied from on-board supply
LK102	A	VDD supplied from on-board supply
LK103	POP	Both 0 Ω resistors placed VDD = 15 V; VSS = –15 V
LK104	NOPOP	Neither 0 Ω resistors placed VDD = 15 V; VSS = –15 V
LK105	NOPOP	Neither 0 Ω resistors placed VDD = 15 V; VSS = –15 V
LK106	POP	Both 0 Ω resistors placed VDD = 15 V; VSS = –15 V
LK701	A	VCC supplied from on-board 5 V supply

POWER SUPPLIES

Take care before applying power and signals to the evaluation board to ensure that all link positions are as required by the operating mode.

When using the EVAL-AD7327SDZ/EVAL-AD7328SDZ in conjunction with the EVAL-SDP-CB1Z board, connect the ac transformer to the J702 connector. VCC, VDD, VSS, and VDRIVE are generated on board.

Each supply is decoupled on the EVAL-AD7327SDZ/EVAL-AD7328SDZ using the 10 μF and 0.1 μF capacitors. A single ground plane is used on this board to minimize the effect of high frequency noise interference.

Table 3. External Power Supply Required

Power Supply	Voltage Range (V)	Purpose
VIN ¹ , J8 or J702	+7 to +9	Supplies all on-board power supplies that generate all the required voltages to run the evaluation board
VDD, J100	+12 to +16.5	Amplifier +VDD
VSS, J100	–12 to –16.5	Amplifier –VSS
VCC, J703	+2.7 to +5.25	ADC supply
VDRIVE, J3	+2.7 to +5.25	Supply voltage for the digital interface circuitry

¹ When this is supplied, all other power supplies are available on-board. If this supply is not used, all other supplies must be sourced from an external source.

SERIAL INTERFACE

The [AD7327/AD7328](#) uses a high speed serial interface that allows sampling rates up to 500 kSPS for the [AD7327](#) and 1 MSPS for the [AD7328](#). For details on the operation of the serial bus, refer to the [AD7327](#) data sheet and the [AD7328](#) data sheet.

The [EVAL-AD7327SDZ/EVAL-AD7328SDZ](#) communicates with the [EVAL-SDP-CB1Z](#) board using level shifters. The [EVAL-SDP-CB1Z](#) operates at a 3.3 V logic level. The level shifters allow the VDRIVE voltages to exceed 3.3 V and be used without damaging the SDP interface.

Details of the serial interface can be found in the [AD7327](#) data sheet and the [AD7328](#) data sheet.

ANALOG INPUTS

The analog inputs on the [EVAL-AD7327SDZ/EVAL-AD7328SDZ](#) are filtered and buffered by the [AD8597](#) ultralow distortion, ultralow noise op amp. The [EVAL-AD7327SDZ/EVAL-AD7328SDZ](#) is configured for single-ended input mode.

The A0 and A1 inputs allow a signal to be connected to the board via the SMB connectors. Alternatively, all signals can be connected via Header J1.

For performance evaluation, using the SMB connections is recommended for the best signal quality on the A0 and A1 inputs.

Each analog input to the [EVAL-AD7327SDZ/EVAL-AD7328SDZ](#) allows a 51 Ω load to be placed on the input, if required. LK1 to LK8 are placed to connect the inputs to the 51 Ω loads.

REFERENCE OPTIONS

The reference source can be from the [AD7327/AD7328](#) REFIN/OUT pin or from an [AD780](#), 5 V/3.0 V, ultrahigh, precision band gap, voltage reference (U12). An external reference voltage may also be applied to Pin 2 of J7.

SOCKETS/CONNECTORS

Table 4. Socket Connection Functions

Socket	Function
J1	A0 to A7 inputs with ground pins adjacent to each signal pin
J2	SDP1Z socket for evaluation control board
J3	External screw connection for VDRIVE
J4	Analog A0 input; buffered to VIN0, AD7327/AD7328
J5	Test point access to VIN0 to VIN7 signals
J6	Analog A1 input; buffered to VIN0, AD7327/AD7328
J7	External connection for serial interface and reference voltage
J8	7 V to 9 V bench supply screw terminal connector
J100	VSS and VDD screw terminal connectors
J702	7 V to 9 V dc transformer power connector
J703	AVCC screw terminal connector

EVAL-AD7327SDZ/EVAL-AD7328SDZ BASIC HARDWARE SETUP

The [AD7327/AD7328](#) evaluation board connects to the SDP board ([EVAL-SDP-CB1Z](#)). The [EVAL-SDP-CB1Z](#) board is the controller board, which is the communication link between the PC and the main evaluation board. Figure 2 shows a photograph of the connections made between the [AD7327/AD7328](#) daughter board and the [EVAL-SDP-CB1Z](#) board.

Before connecting power, connect the [EVAL-AD7327SDZ/EVAL-AD7328SDZ](#) board to Connector A or Connector B on the [EVAL-SDP-CB1Z](#) board. Use the nylon screws included in the [EVAL-AD7327SDZ/EVAL-AD7328SDZ](#) evaluation kit and to ensure the [EVAL-AD7327SDZ/EVAL-AD7328SDZ](#) board and the [EVAL-SDP-CB1Z](#) board are connected firmly together.

When the [EVAL-AD7327SDZ/EVAL-AD7328SDZ](#) board and the [EVAL-SDP-CB1Z](#) board are connected securely, connect the power supplies on the [EVAL-AD7327SDZ/EVAL-AD7328SDZ](#) board. The [EVAL-AD7327SDZ/EVAL-AD7328SDZ](#) requires an external power supply, which is included in the evaluation board kit. Connect this power supply to the J702 connector on the [EVAL-AD7327SDZ/EVAL-AD7328SDZ](#) board. Alternatively, a bench power supply can be used to power the [EVAL-AD7327SDZ/EVAL-AD7328SDZ](#) via J8. Further details on the required power supplies connections and options are detailed in Table 4.

Before connecting the [EVAL-SDP-CB1Z](#) board to a PC, ensure that the [AD7327/AD7328](#) software has been installed from the enclosed CD. The full software installation procedure is detailed in the Evaluation Board Software section.

Finally, connect the [EVAL-SDP-CB1Z](#) board to the PC via the USB cable enclosed in the [EVAL-SDP-CB1Z](#) kit. If using the Windows XP® platform, the [EVAL-SDP-CB1Z](#) drivers may need to be searched for. If prompted by the operating system, choose to automatically search for the drivers for the [EVAL-SDP-CB1Z](#) board.

EVALUATION BOARD SOFTWARE

SOFTWARE INSTALLATION

The [EVAL-AD7327SDZ/EVAL-AD7328SDZ](#) evaluation kit includes software on a CD. Click the **setup.exe** file from the CD to run the install. The default location for the software is the following: C:\Program Files\Analog Devices\AD7327_28.

Install the evaluation software before connecting the evaluation board and the [EVAL-SDP-CB1Z](#) board to the USB port of the PC to ensure that the evaluation system is correctly recognized when connected to the PC.

There are two parts to the installation

- [AD7327/AD7328](#) evaluation board software install
- [EVAL-SDP-CB1Z](#) SDP board drivers install

Figure 3 to Figure 7 show the separate stages of the [AD7327/AD7328](#) evaluation software. Figure 8 to Figure 12 show the separate steps to install the [EVAL-SDP-CB1Z](#) drivers. Proceed through all of the installation steps allowing the software and drivers to be placed in the appropriate locations. Only after the software and drivers have been installed should the [EVAL-SDP-CB1Z](#) board be connected to the PC.



Figure 5. Install Window 3

10732-006

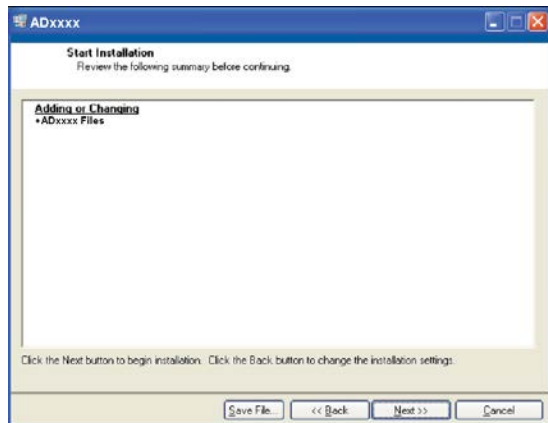

Figure 6. AD7327/AD7328 Install Window 4

10732-007

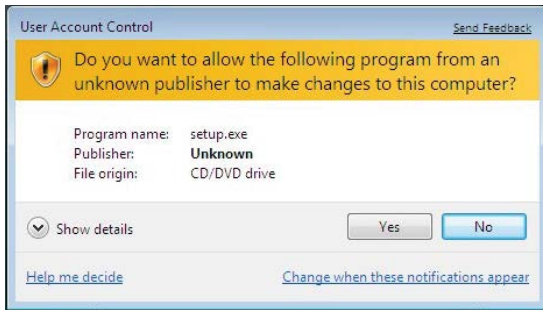

Figure 3. AD7327/AD7328 Install Window 1

10732-004

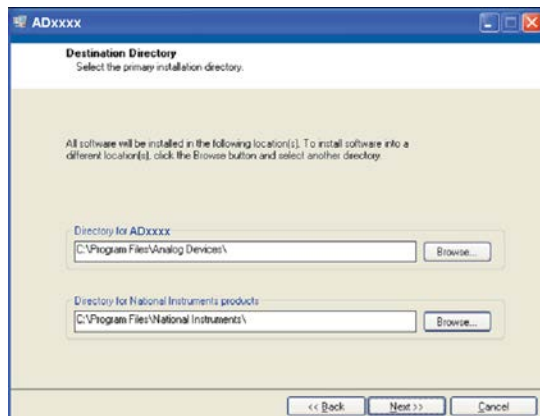

Figure 4. AD7327/AD7328 Install Window 2

10732-005

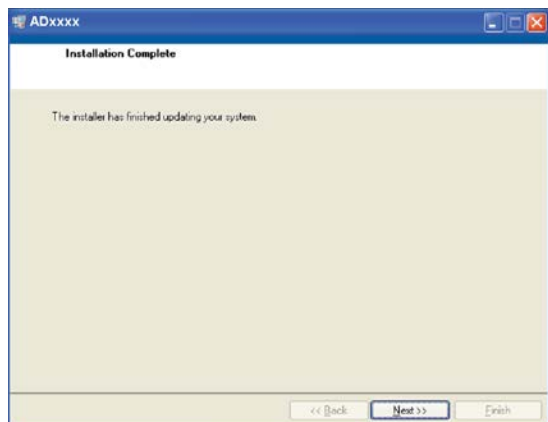

Figure 7. AD7327/AD7328 Install Window 5

10732-008

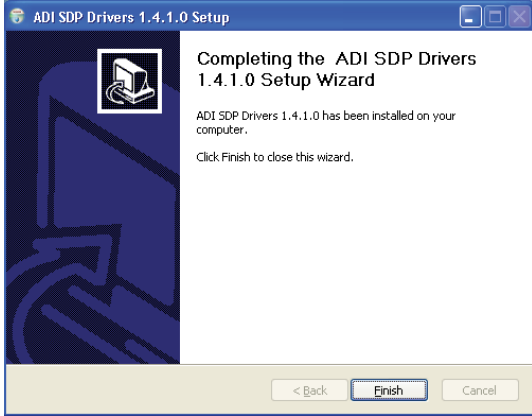

Figure 8. EVAL-SDP-CB1Z Drivers Setup Window 1

10732-009

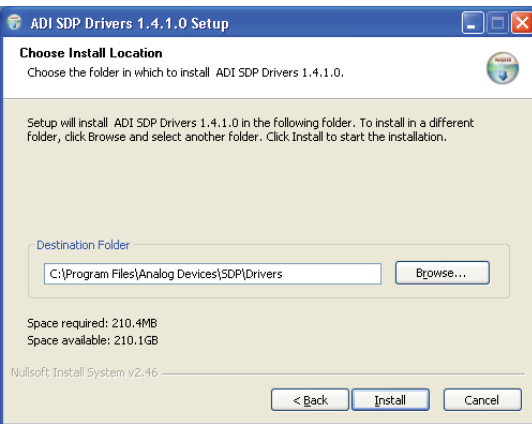

Figure 9. EVAL-SDP-CB1Z Drivers Setup Window 2

10732-010

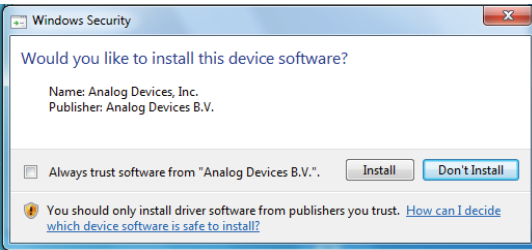

Figure 10. EVAL-SDP-CB1Z Drivers Setup Window 3

10732-011

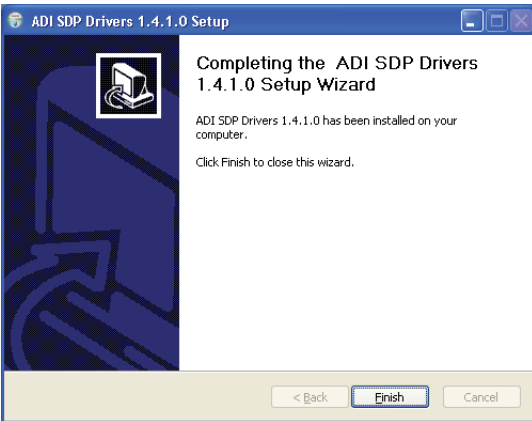

Figure 11. EVAL-SDP-CB1Z Drivers Setup Window 4

10732-012

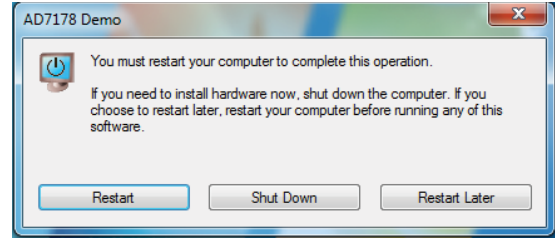

Figure 12. EVAL-SDP-CB1Z Drivers Setup Window 5

10732-013

After installation from the CD is complete, connect the EVAL-AD7327SDZ/EVAL-AD7328SDZ board to the EVAL-SDP-CB1Z board as described in the Evaluation Board Hardware section.

When the EVAL-SDP-CB1Z board is first plugged in via the USB cable provided, allow the **Found New Hardware Wizard** to run. Once the drivers are installed, ensure that the board has connected correctly by looking at the **Device Manager** of the PC. When the EVAL-SDP-CB1Z board appears under **ADI Development Tools**, the installation is completed.

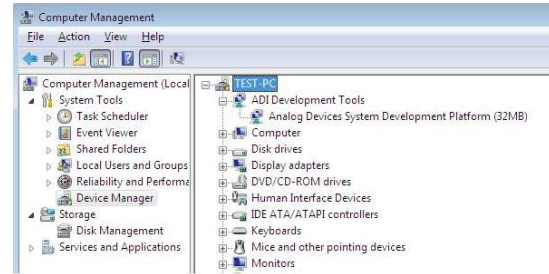

Figure 13. Device Manager

10732-014

LAUNCHING THE SOFTWARE

When the [EVAL-AD7327SDZ/EVAL-AD7328SDZ](#) and [EVAL-SDP-CB1Z](#) are correctly connected to the PC, the [AD7327/AD7328](#) software can be launched.

To launch the software, complete the following steps:

1. From the **Start** menu, select **Programs/Analog Devices/AD7327/AD7328**. The main window of the software then displays.
2. If the [AD7327/AD7328](#) evaluation system is not connected to the USB port via the [EVAL-SDP-CB1Z](#) when the software is launched, a connectivity error displays (see Figure 14). Connect the evaluation board to the USB port of the PC, wait a few seconds, click **Rescan**, and follow the instructions.

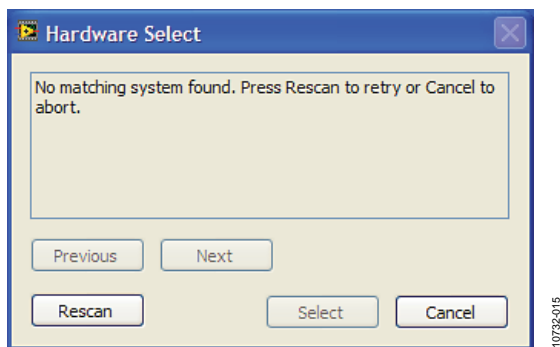

Figure 14. Connectivity Error Alert

SOFTWARE OPERATION

When the software is launched, the panel opens and the software looks for hardware connected to the PC. The software detects the generic attached to the PC and returns this in a user dialog box. The user software panel then launches as shown in Figure 15.

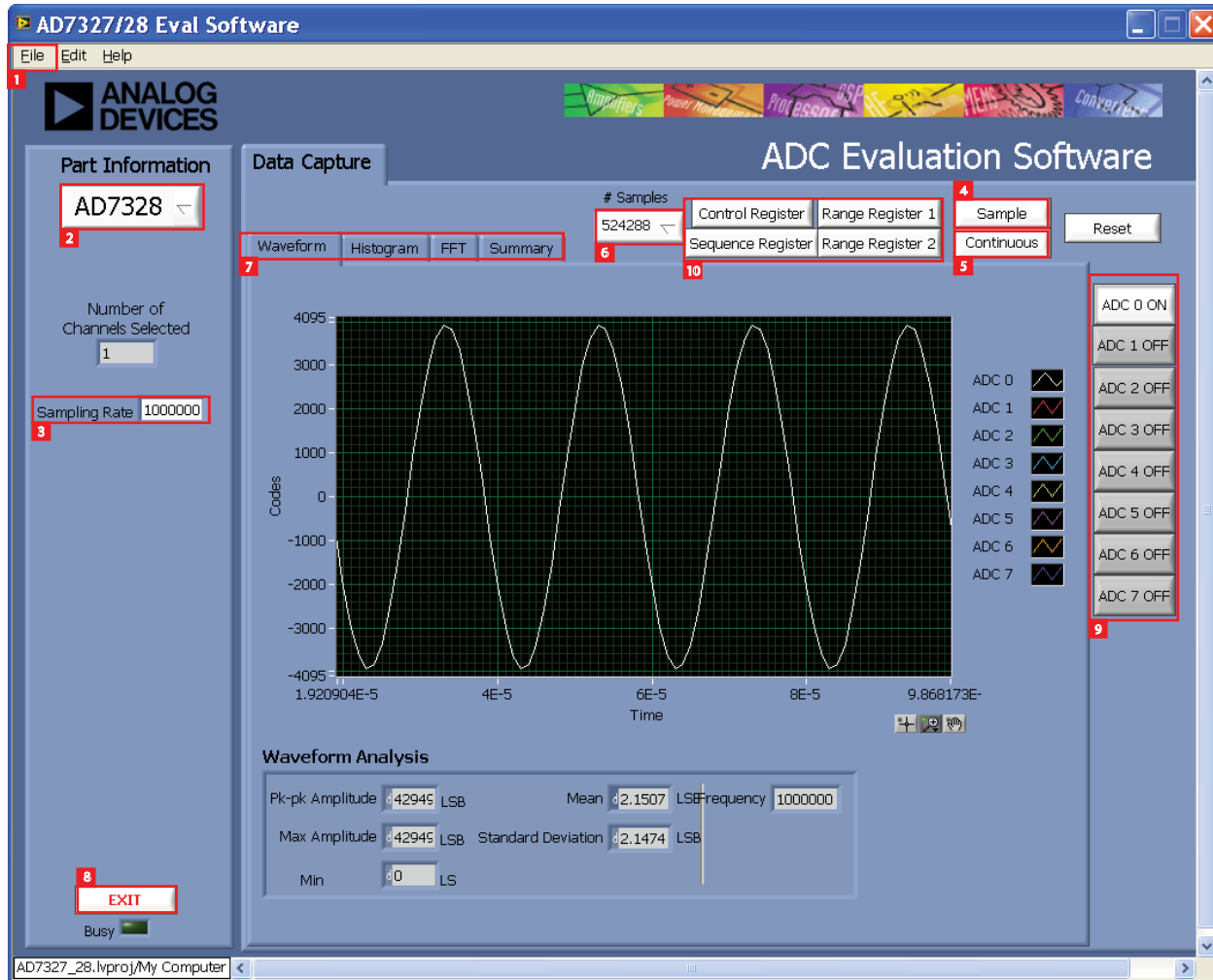

Figure 15. User Software Panel, Setup Screen

DESCRIPTION OF USER SOFTWARE PANEL

The user software panel, as shown in Figure 15, has the following features:

1. **File** menu with the choice of the following:
 - a. **Load data:** load previously captured data in .tsv (tab separated values) format for analysis
 - b. **Save Data as .tsv:** save captured data in .tsv) format for future analysis
 - c. **Print Front Panel Picture:** use to print the front panel to the default printer.
 - d. **Save Picture:** use to save the current screen capture
 - e. **EXIT**
2. Use this drop-down menu to select the generic, [AD7327](#) or [AD7328](#).
3. **Sampling Rate:** The default sampling frequency matches the maximum sample rate of the ADC selected from the drop-down menu. User can adjust the sampling frequency; however, there are limitations around the sample frequency, where unusable sample frequencies are input, and the software automatically adjusts the sample frequency accordingly. Units can be entered such as 10k for 10,000 Hz. As the maximum sample frequency possible is device dependent, with some of the ADCs capable of operating up to 250 kSPS, while others can run to 1.3 MSPS, the software matches the particular ADC ability. If the user enters a value larger than the ability of the existing device, the software indicates this and reverts to the maximum sample frequency.
4. **Sample:** to perform a single capture.
5. **Continuous:** to perform a continuous capture from the ADC. Press a second time to stop sampling.
6. Select the number of samples (**# Samples**) to analyze.
7. There are four tabs available displaying the data in different formats, these are listed here and described in more detail in the Data Capture/WaveForm Tab, AC Testing—Data Capture/Histogram Tab, DC Testing—Data Capture/Histogram Tab, AC Testing—Data Capture/FFT Tab, and Data Capture/Summary Tab sections.
 - a. **Waveform**
 - b. **Histogram**
 - c. **FFT**
 - d. **Summary**

8. **EXIT** button. Use this button to exit the software. Alternatively, go to **File/Exit**.
9. Channel display buttons. Use these to display multiple channel reads on the display. For FFT analysis, select only one channel.
10. Registers (**Control Register**, **Sequence Register**, **Range Register 1**, and **Range Register 2**). Use these buttons to access the register settings dialog boxes. See the Register Controls section for more details.

Within any of the chart panels, the following tools allow user control of the different chart displays.



is used for controlling the cursor. if present.



is used for zooming in and out.



is used for panning.

Click **Save Plot** to save plots.

REGISTER CONTROLS

There are four registers used to control the operations of the [AD7327/AD7328](#). For detailed settings of these registers, refer to the relevant data sheet.



Figure 16. **Control Register** Dialog Box

The **Control Register** sets up the addressing, modes, and power management, as well as setting the sequence, coding, and reference source (see Figure 16).



Figure 17. **Sequence Register** Dialog Box

The **Sequence Register** selects which channels are included in the channel sequencing (see Figure 17).



Figure 18. **Range Register1** Dialog Box



Figure 19. **Range Register2** Dialog Box

Range Register 1 and **Range Register 2** allow the range of each channel to be individually selected (Figure 18 and Figure 19).

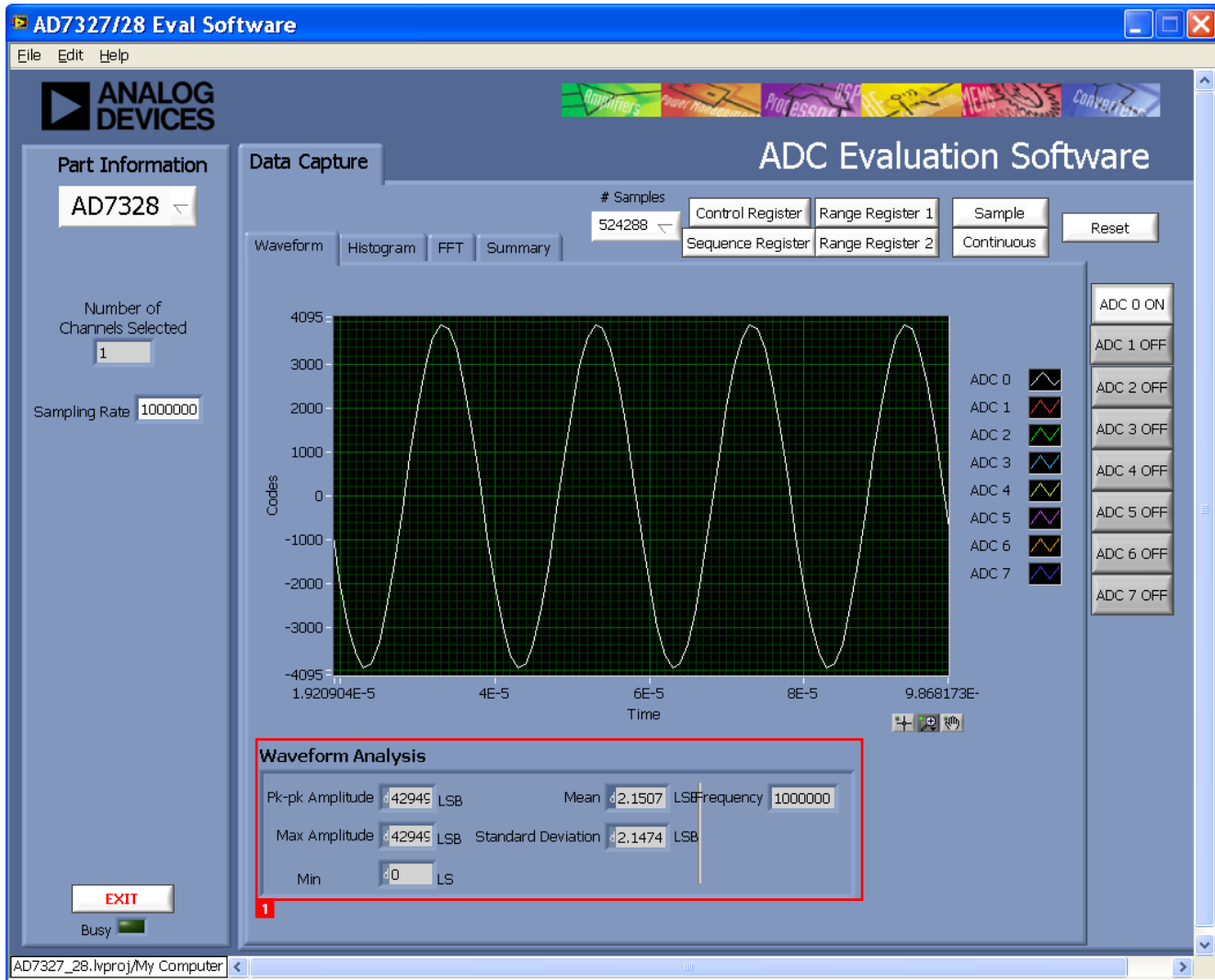

Figure 20. Data Capture/Waveform Tab

DATA CAPTURE/WAVEFORM TAB

Figure 20 illustrates the **Data Capture/Waveform** tab. The input signal here is a 50 kHz sine wave.

Number 1 in Figure 20 shows that the waveform analysis reports back the amplitudes recorded from the captured signal in addition to the frequency of the signal tone (see Figure 20).

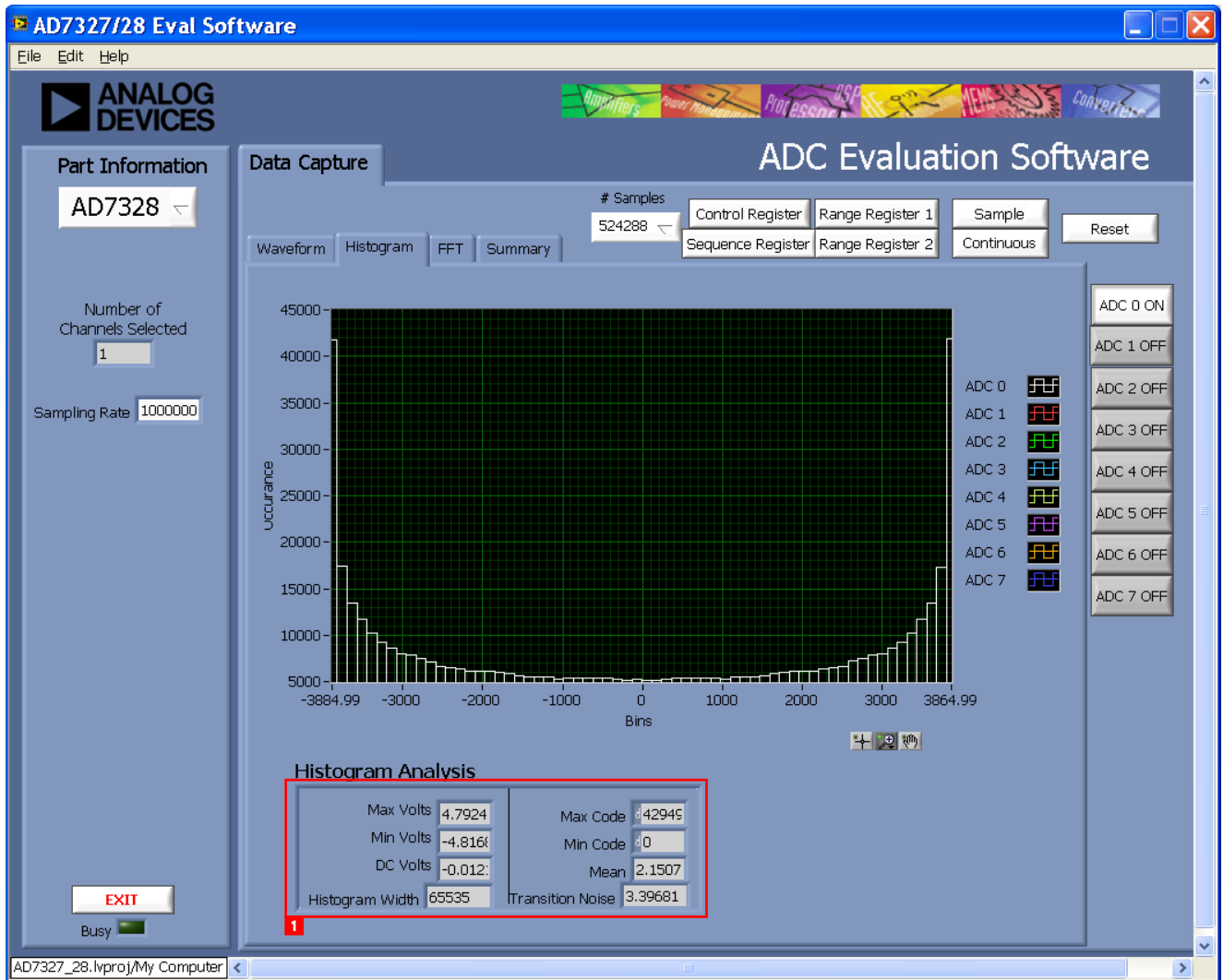

Figure 21. Data Capture/Histogram Tab

AC TESTING—DATA CAPTURE/HISTOGRAM TAB

Figure 21 shows the **Data Capture/Histogram** tab. This tab allows the user to test the ADC for the code distribution for ac input and computes the mean and standard deviation, or transition noise of the converter, and displays the results.

Raw data is captured and then passed to the PC for statistical computations. To perform a histogram test, select the **Histogram** tab and click **Sample**.

An ac histogram needs a quality signal source applied to the input of the SK1/SK3 connectors. Figure 21 shows the histogram for a 50 kHz sine wave applied to the ADC input and the results calculated.

Number 1 in Figure 21 illustrates the different measured values for the data captured.

DC TESTING—DATA CAPTURE/HISTOGRAM TAB

More commonly, the histogram is used for dc testing, where the ADC is tested for the code distribution for dc input and computes the mean and standard deviation, or transition noise of the converter, and displays the results. Raw data is captured and passed to the PC for statistical computations. To perform a histogram test, select the **Histogram** tab click **Sample**.

A histogram test can be performed without an external source because the evaluation board has a buffered $V_{REF}/2$ source at the ADC input. To test other dc values, apply a source to the J3 and J4 inputs. To make the dc source noise compatible with that of the ADC, it may be required to filter the signal.

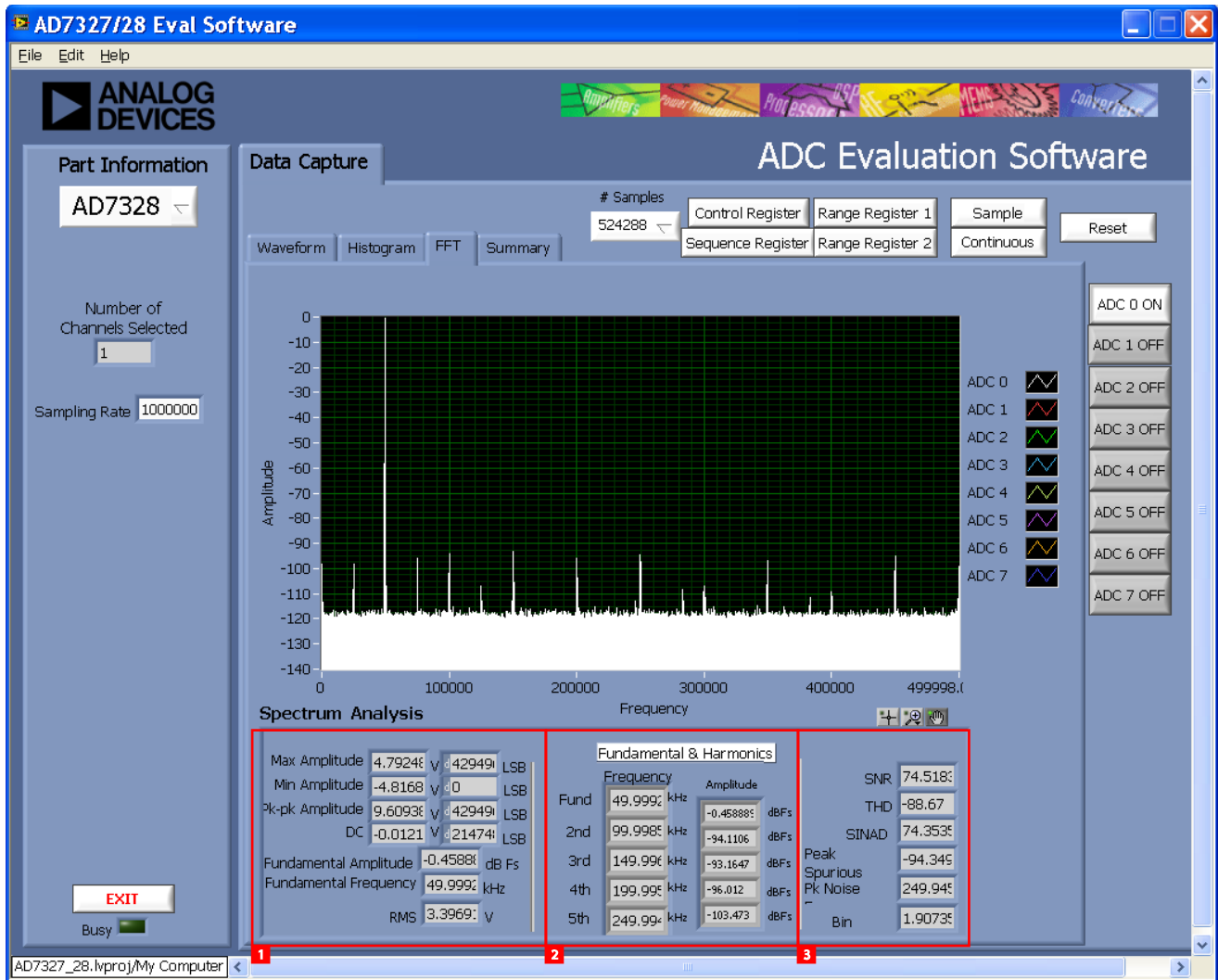

Figure 22. Data Capture/FFT Tab

AC TESTING—DATA CAPTURE/FFT TAB

Figure 22 shows the **Data Capture/FFT** tab. This tests the traditional ac characteristics of the converter and displays a Fast Fourier Transform (FFT) of the results. As in the histogram test, raw data is captured and passed to the PC, where the FFT is performed displaying the signal-to-noise ratio (SNR), signal-to-noise-and-distortion ratio (SINAD), total harmonic distortion (THD), and spurious-free dynamic range (SFDR). To perform an ac test, apply a sinusoidal signal to the evaluation board at the SMB inputs, J4 and J6. Low distortion, better than 115 dB, is required to allow true evaluation of the part. One possibility is to filter the input signal from the ac source. There is no suggested

band-pass filter; however, take consideration in the choice. Furthermore, if using a low frequency, band-pass filter when the full-scale input range is more than a few volts peak-to-peak, use the on-board amplifiers to amplify the signal, thus preventing the filter from distorting the input signal.

Figure 22 displays the results of the captured data.

- Shows the input signal information
- Displays the fundamental frequency (**Fund**) and amplitude in addition to the second (**2nd**) to fifth (**5th**) harmonics.
- Displays the performance data: **SNR**, **THD**, **SINAD**, **Peak Spurious**, **Pk Noise Freq**, and **Bin**.

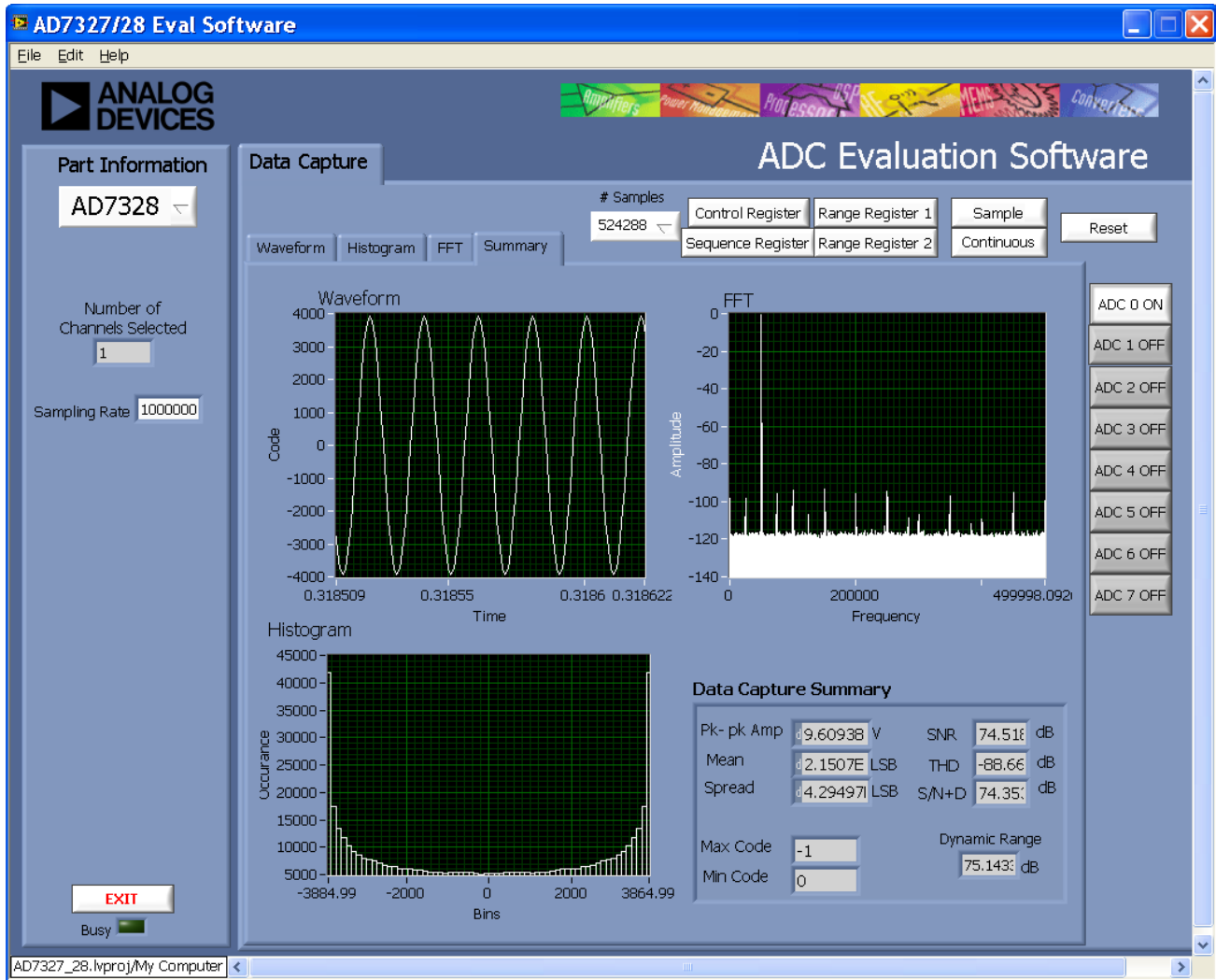

Figure 23. Data Capture/Summary Tab

DATA CAPTURE/SUMMARY TAB

Figure 23 shows the **Data Capture/Summary** tab. It captures all the display information and provides it in one panel with a synopsis of the information, including key performance parameters, such as SNR and THD.

SAVE FILE

The software can save the current captured data for later analysis to a .tsv file (see Figure 24). Window users are prompted to save to an appropriate folder location.

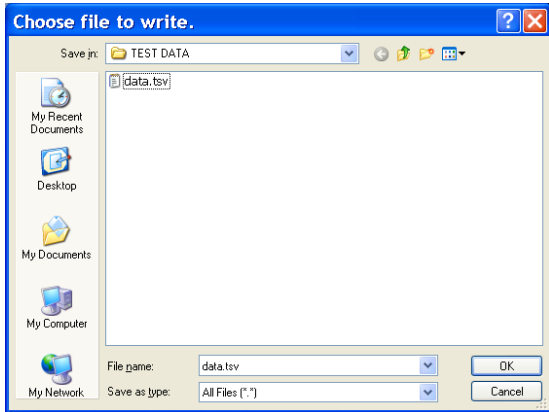

Figure 24. Save File Dialog Box (**Choose file to write.**)

LOAD FILE

In the **Choose file to read.** window, users are prompted to load the file (see Figure 25). User may have to navigate to find these example files. The default location for the example files is: **C:\Program Files\Analog Devices\AD7327_28\examples.**

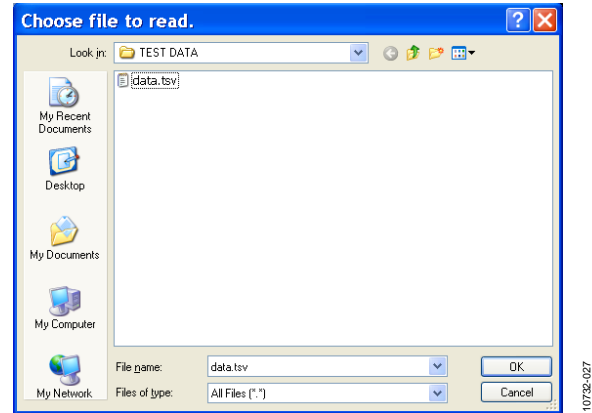

Figure 25. Load File Dialog Box (**Choose file to read.**)

EVALUATION BOARD SCHEMATICS AND ARTWORK

107232-028

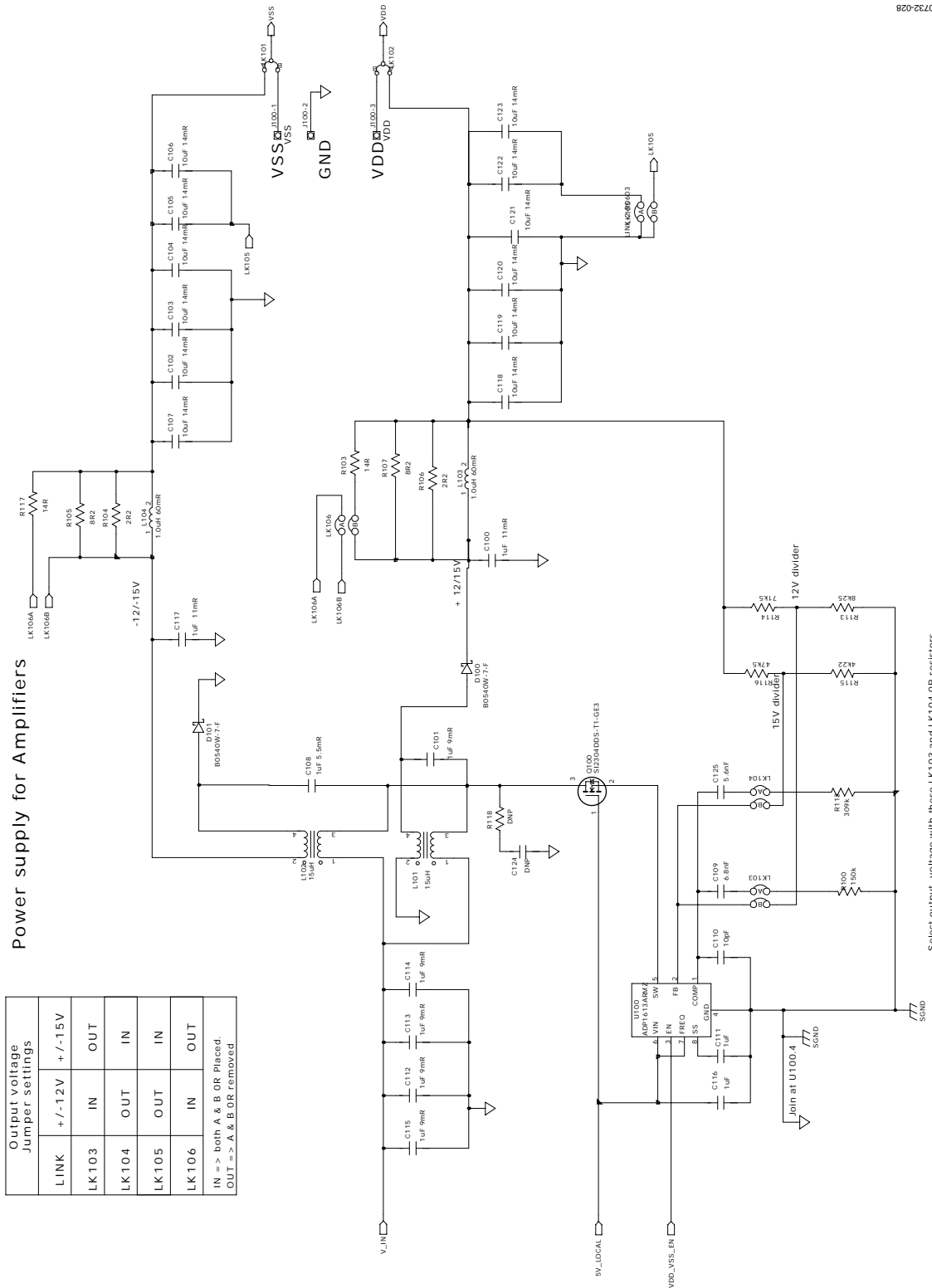

Figure 26. Schematic Page 1

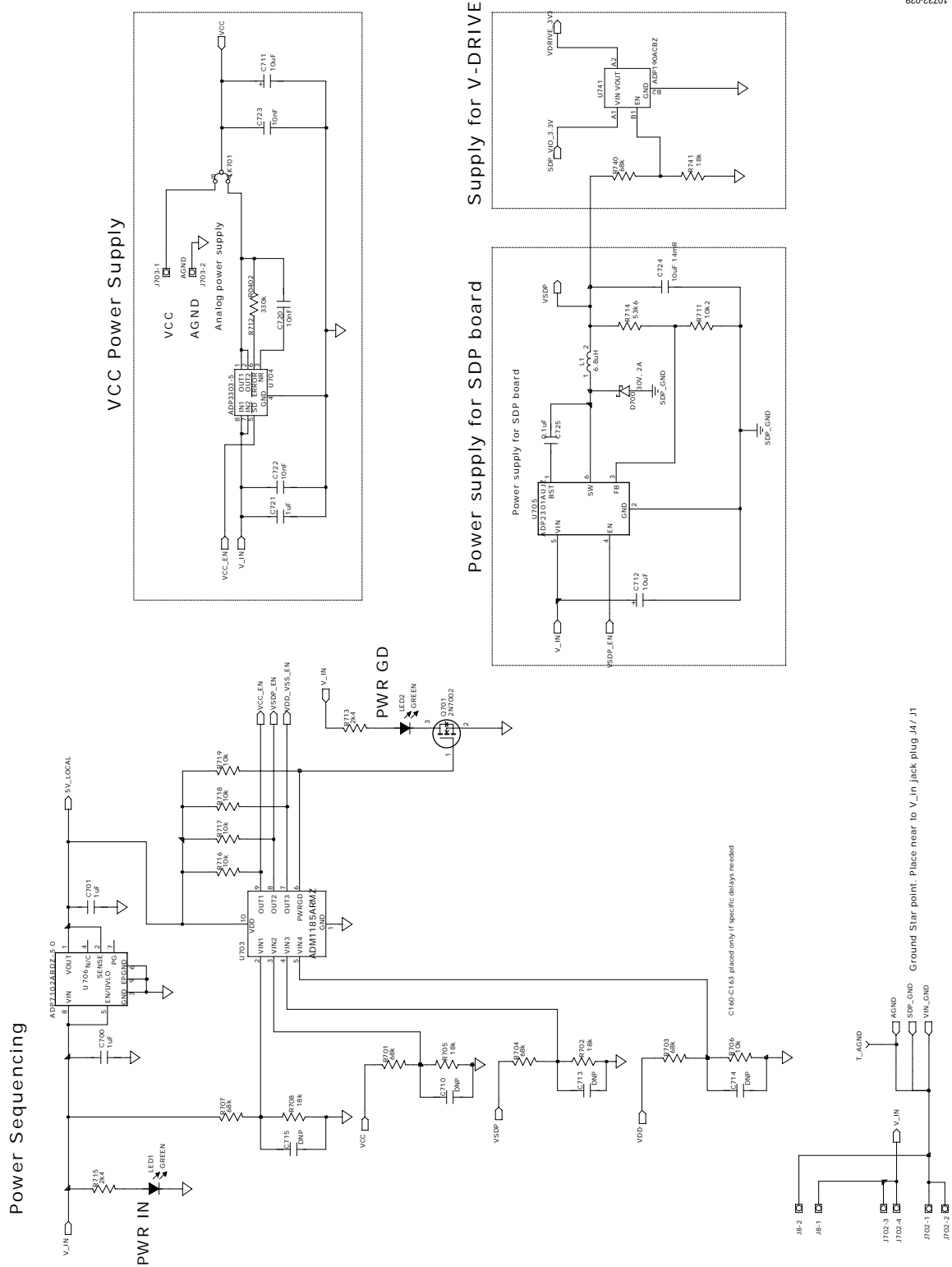

Figure 27. Schematic Page 2

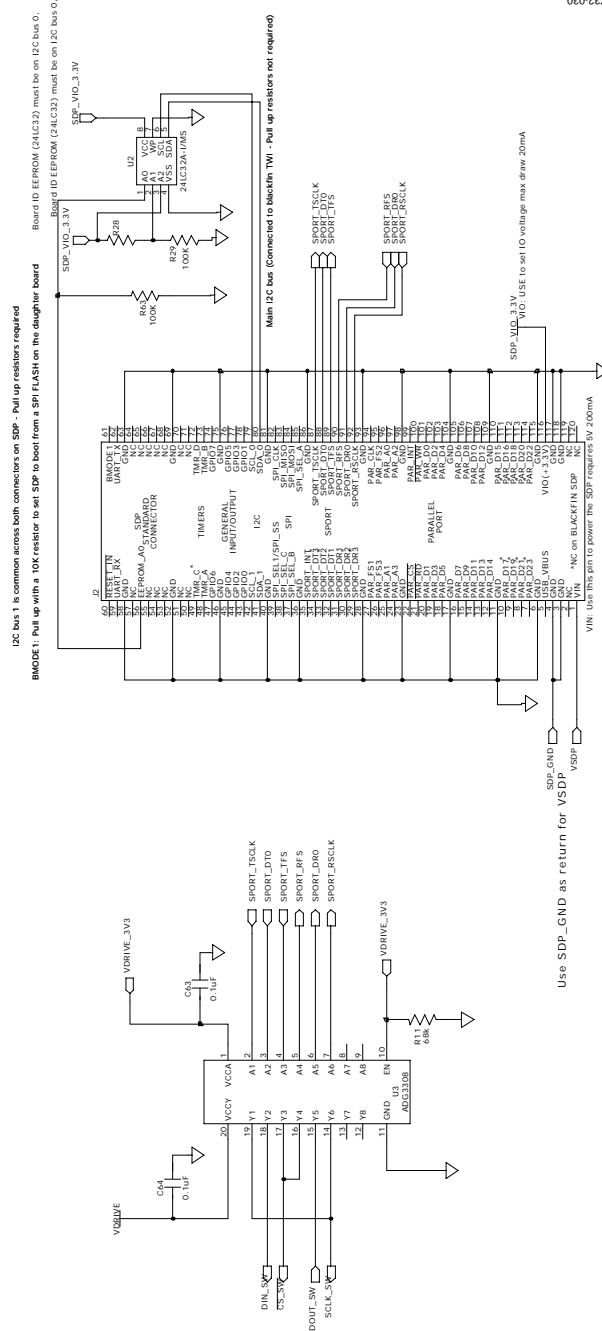

Figure 28. Schematic Page 3

ADC DRIVERS

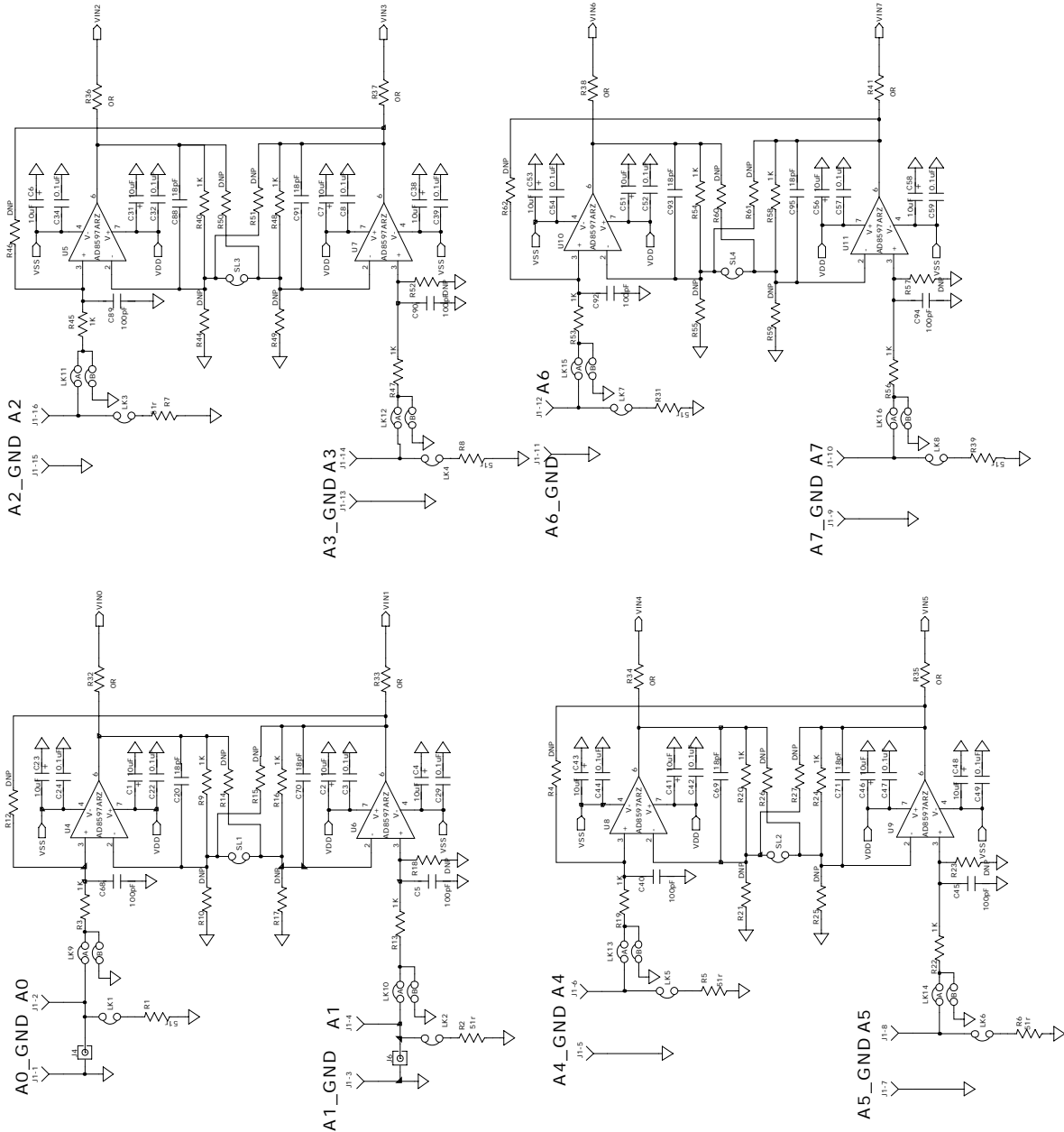

Figure 29. Schematic Page 4

10732-032

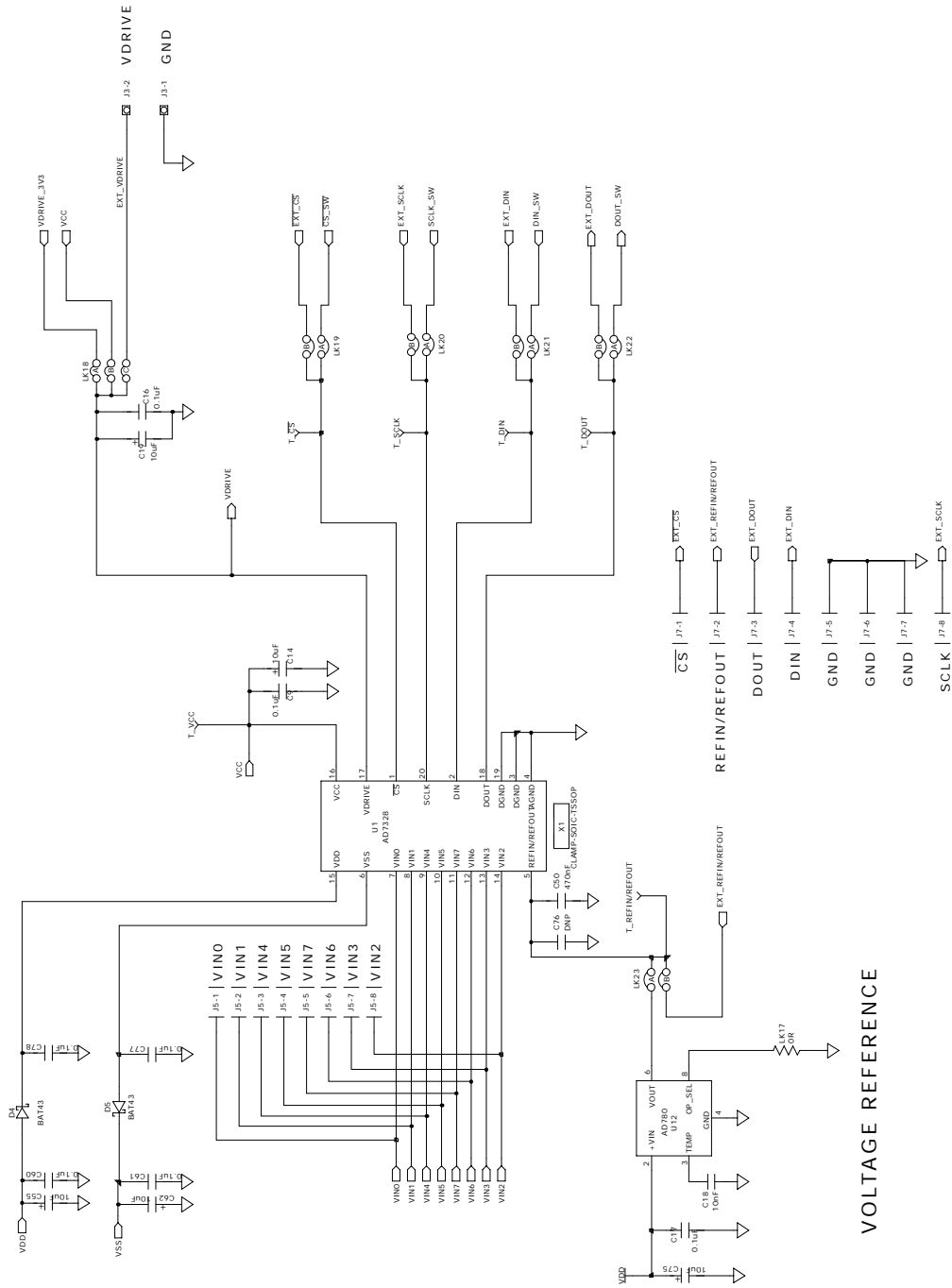

Figure 30. Schematic Page 5

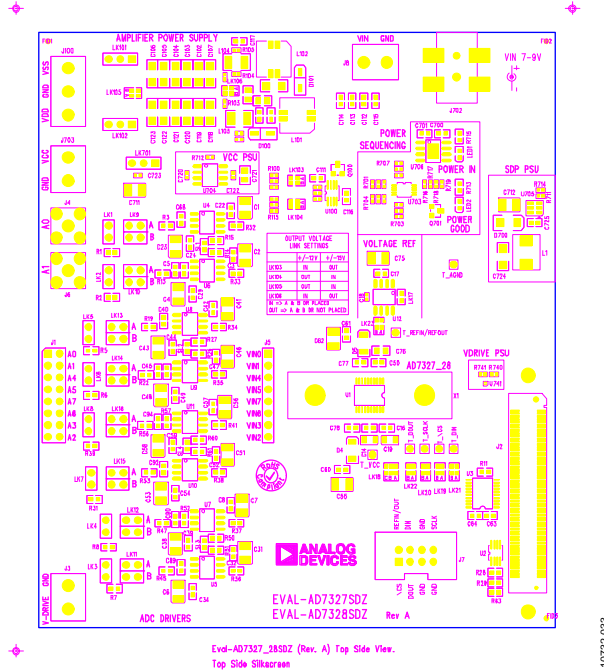

Figure 31. Top Printed Circuit Board (PCB) Silkscreen

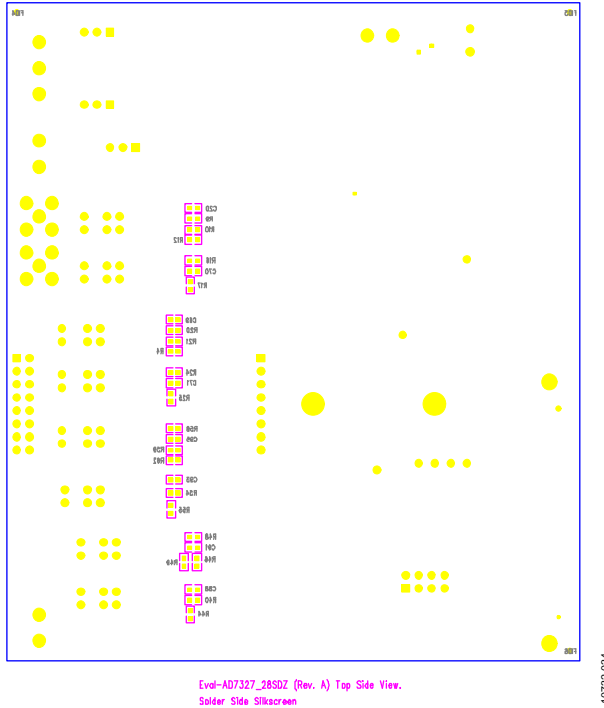
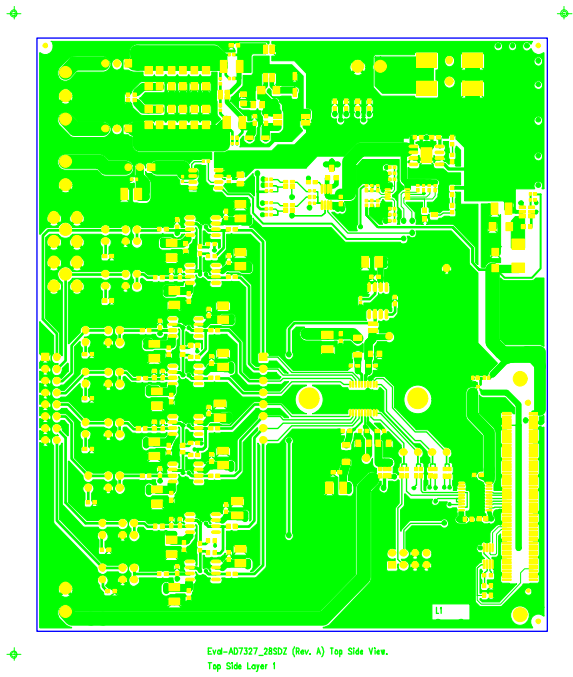

Figure 32. Bottom Printed Circuit Board (PCB) Silkscreen



Evd-AD7327_28SDZ (Rev. A) Top Side View.
Top Side Layer 1

Figure 33. Layer 1 Component Side View

10732-035

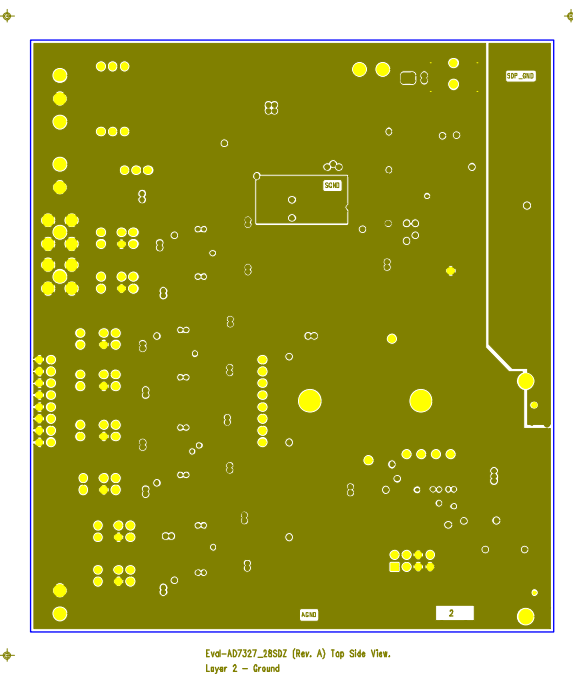

Evd-AD7327_28SDZ (Rev. A) Top Side View.
Layer 2 - Ground

Figure 34. Layer 2 Component Side View

10732-036

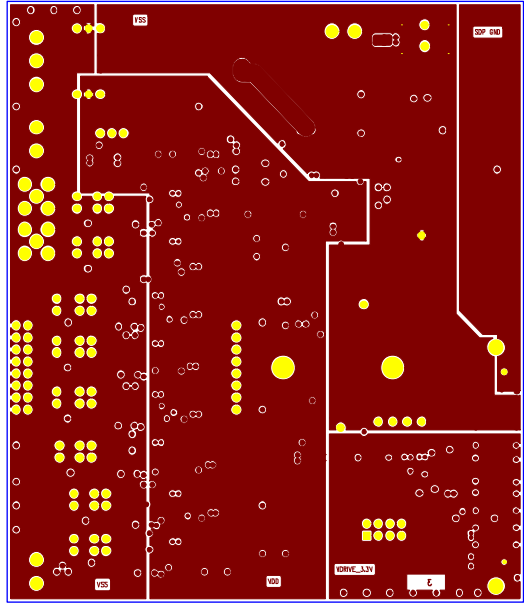

Eval-AD7327_2850Z (Rev. A) Top Side View.
Layer 3 - Power

Figure 35. Layer 3 Component Side View

10732-038

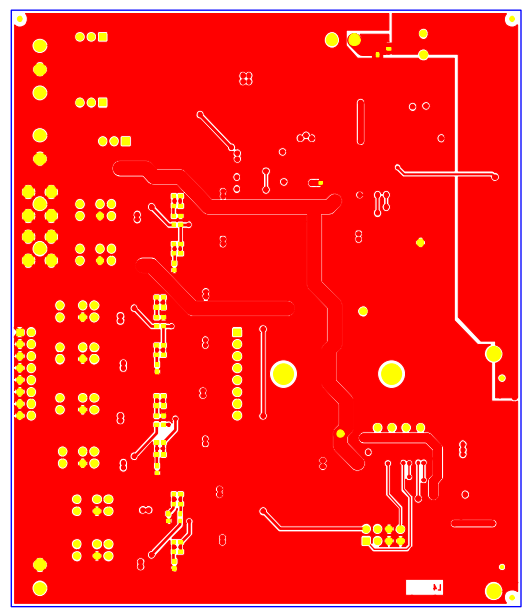

Eval-AD7327_2850Z (Rev. A) Top Side View.
Bottom Side Layer 4

Figure 36. Layer 4 Component Side View

10732-037

NOTES

NOTES

**ESD Caution**

ESD (electrostatic discharge) sensitive device. Charged devices and circuit boards can discharge without detection. Although this product features patented or proprietary protection circuitry, damage may occur on devices subjected to high energy ESD. Therefore, proper ESD precautions should be taken to avoid performance degradation or loss of functionality.

Legal Terms and Conditions

By using the evaluation board discussed herein (together with any tools, components documentation or support materials, the "Evaluation Board"), you are agreeing to be bound by the terms and conditions set forth below ("Agreement") unless you have purchased the Evaluation Board, in which case the Analog Devices Standard Terms and Conditions of Sale shall govern. Do not use the Evaluation Board until you have read and agreed to the Agreement. Your use of the Evaluation Board shall signify your acceptance of the Agreement. This Agreement is made by and between you ("Customer") and Analog Devices, Inc. ("ADI"), with its principal place of business at One Technology Way, Norwood, MA 02062, USA. Subject to the terms and conditions of the Agreement, ADI hereby grants to Customer a free, limited, personal, temporary, non-exclusive, non-sublicensable, non-transferable license to use the Evaluation Board FOR EVALUATION PURPOSES ONLY. Customer understands and agrees that the Evaluation Board is provided for the sole and exclusive purpose referenced above, and agrees not to use the Evaluation Board for any other purpose. Furthermore, the license granted is expressly made subject to the following additional limitations: Customer shall not (i) rent, lease, display, sell, transfer, assign, sublicense, or distribute the Evaluation Board; and (ii) permit any Third Party to access the Evaluation Board. As used herein, the term "Third Party" includes any entity other than ADI, Customer, their employees, affiliates and in-house consultants. The Evaluation Board is NOT sold to Customer; all rights not expressly granted herein, including ownership of the Evaluation Board, are reserved by ADI. CONFIDENTIALITY. This Agreement and the Evaluation Board shall all be considered the confidential and proprietary information of ADI. Customer may not disclose or transfer any portion of the Evaluation Board to any other party for any reason. Upon discontinuation of use of the Evaluation Board or termination of this Agreement, Customer agrees to promptly return the Evaluation Board to ADI. ADDITIONAL RESTRICTIONS. Customer may not disassemble, decompile or reverse engineer chips on the Evaluation Board. Customer shall inform ADI of any occurred damages or any modifications or alterations it makes to the Evaluation Board, including but not limited to soldering or any other activity that affects the material content of the Evaluation Board. Modifications to the Evaluation Board must comply with applicable law, including but not limited to the RoHS Directive. TERMINATION. ADI may terminate this Agreement at any time upon giving written notice to Customer. Customer agrees to return to ADI the Evaluation Board at that time. LIMITATION OF LIABILITY. THE EVALUATION BOARD PROVIDED HEREUNDER IS PROVIDED "AS IS" AND ADI MAKES NO WARRANTIES OR REPRESENTATIONS OF ANY KIND WITH RESPECT TO IT. ADI SPECIFICALLY DISCLAIMS ANY REPRESENTATIONS, ENDORSEMENTS, GUARANTEES, OR WARRANTIES, EXPRESS OR IMPLIED, RELATED TO THE EVALUATION BOARD INCLUDING, BUT NOT LIMITED TO, THE IMPLIED WARRANTY OF MERCHANTABILITY, TITLE, FITNESS FOR A PARTICULAR PURPOSE OR NON-INFRINGEMENT OF INTELLECTUAL PROPERTY RIGHTS. IN NO EVENT WILL ADI AND ITS LICENSORS BE LIABLE FOR ANY INCIDENTAL, SPECIAL, INDIRECT, OR CONSEQUENTIAL DAMAGES RESULTING FROM CUSTOMER'S POSSESSION OR USE OF THE EVALUATION BOARD, INCLUDING BUT NOT LIMITED TO LOST PROFITS, DELAY COSTS, LABOR COSTS OR LOSS OF GOODWILL. ADI'S TOTAL LIABILITY FROM ANY AND ALL CAUSES SHALL BE LIMITED TO THE AMOUNT OF ONE HUNDRED US DOLLARS (\$100.00). EXPORT. Customer agrees that it will not directly or indirectly export the Evaluation Board to another country, and that it will comply with all applicable United States federal laws and regulations relating to exports. GOVERNING LAW. This Agreement shall be governed by and construed in accordance with the substantive laws of the Commonwealth of Massachusetts (excluding conflict of law rules). Any legal action regarding this Agreement will be heard in the state or federal courts having jurisdiction in Suffolk County, Massachusetts, and Customer hereby submits to the personal jurisdiction and venue of such courts. The United Nations Convention on Contracts for the International Sale of Goods shall not apply to this Agreement and is expressly disclaimed.